

THIS DRAWING IS UNPUBLISHED. RELEASED FOR PUBLICATION
 © COPYRIGHT copyright.d8Te- ALL RIGHTS RESERVED.

REVISIONS				
P	LTR	DESCRIPTION	DATE	APVD
A4		REVISED PER ECR-15-000039	05FEB2015	O.C D.Z

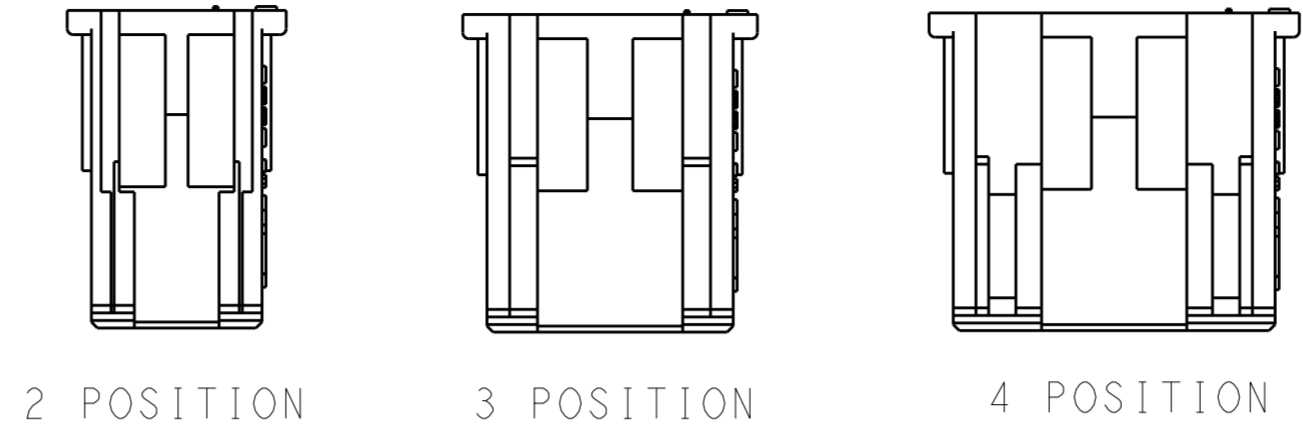

- 1 MATERIAL: NYLON UL94V-0
 COLOR: NATURAL FOR 1969442-2 THRU 2-1969442-0
 COLOR: RED FOR 3-1969442-4.
- 2 ACCEPTS TE RECEPTACLE
 P/N'S 2110989-()
- 3 THESE HOUSINGS CAN ACCEPT
 OPTIONAL TPA (RETAINER)
 P/N 1969443-()
- 4 MATES WITH TE HEADER ASSEMBLIES
 2132230-() & 2132415-()
- 5 PRELIMINARY - NOT FOR PRODUCTION

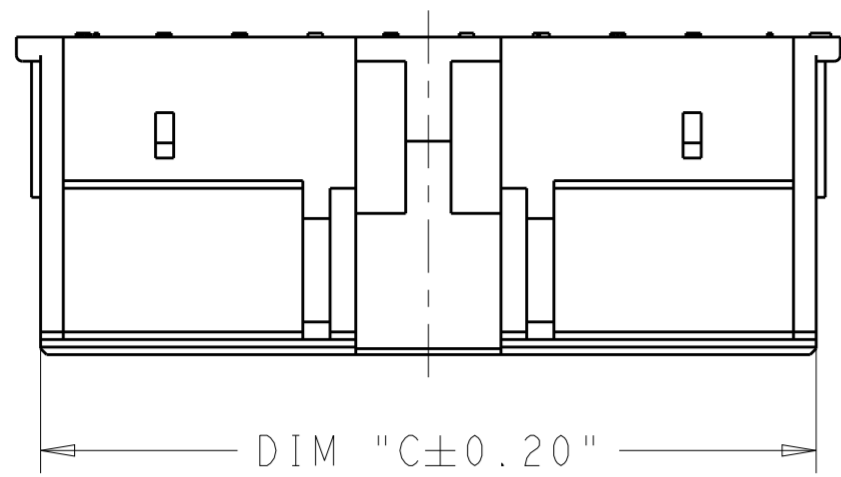
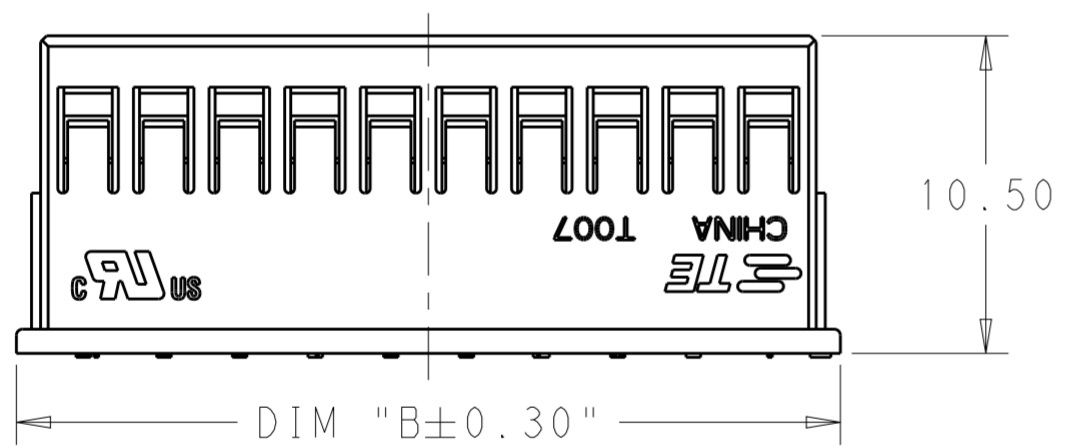
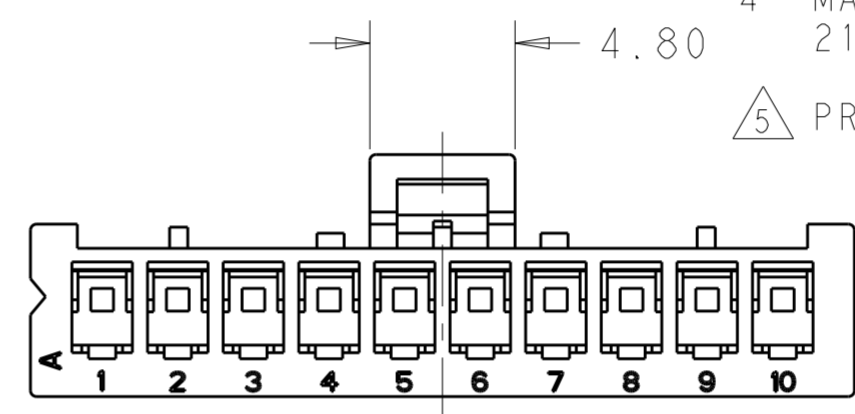
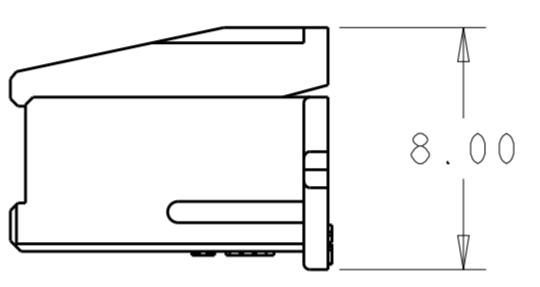
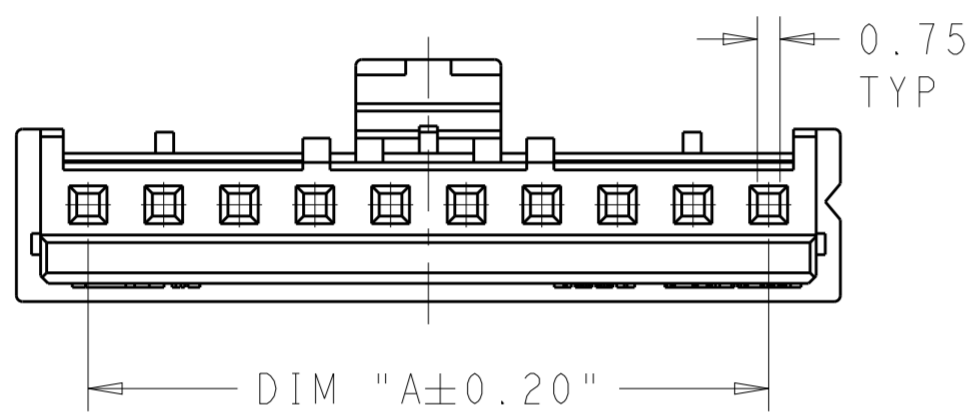

35.64	37.3	32.5	14	5 3-1969442-4
50.64	52.3	47.5	20	2-1969442-0
48.14	49.8	45.0	19	1-1969442-9
45.64	47.3	42.5	18	1-1969442-8
43.14	44.8	40.0	17	1-1969442-7
40.64	42.3	37.5	16	1-1969442-6
38.14	39.8	35.0	15	1-1969442-5
35.64	37.3	32.5	14	1-1969442-4
33.14	34.8	30.0	13	1-1969442-3
30.64	32.3	27.5	12	1-1969442-2
28.14	29.8	25.0	11	1-1969442-1
25.64	27.3	22.5	10	1-1969442-0
23.14	24.8	20.0	9	1969442-9
20.64	22.3	17.5	8	1969442-8
18.14	19.8	15.0	7	1969442-7
15.64	17.3	12.5	6	1969442-6
13.14	14.8	10.0	5	1969442-5
10.64	12.3	7.5	4	1969442-4
8.14	9.8	5.0	3	1969442-3
5.64	7.3	2.5	2	1969442-2
DIM C	DIM B	DIM A	NO. OF POSITIONS	PART NUMBER

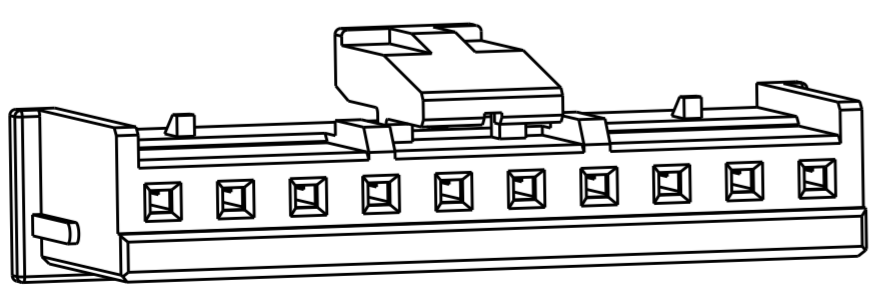

THIS DRAWING IS A CONTROLLED DOCUMENT.

DWN: JR RUTH 05-Feb-15
 CHK: TOM MICHIELUTTI 27FEB14
 APVD: TOM MICHIELUTTI 27FEB14

STE TE Connectivity

NAME: ECONOMY POWER 2.5 TPA HOUSING

PRODUCT SPEC: 108-2418
 APPLICATION SPEC: 114-13315

SIZE: A2 CAGE CODE: - DRAWING NO: C-1969442 RESTRICTED TO: -
 WEIGHT: - SCALE: N/A SHEET 1 OF 1 REV A4

MATERIAL: - DIMENSIONS: mm TOLERANCES UNLESS OTHERWISE SPECIFIED: 0 PLC ±- 1 PLC ±- 2 PLC ±0.25 3 PLC ±- 4 PLC ±- ANGLES ±- FINISH

Customer Drawing